

(No Model.)

F. H. RICHARDS.  
CHUCK.

No. 562,421.

Patented June 23, 1896.

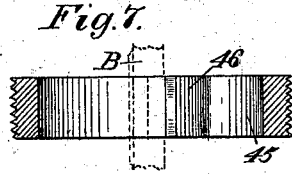
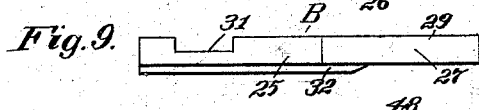
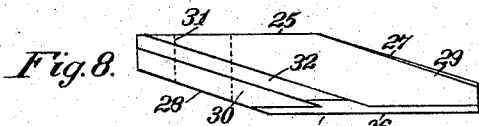
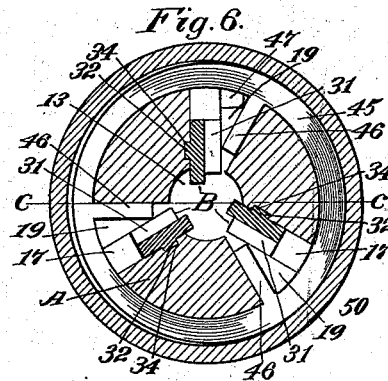
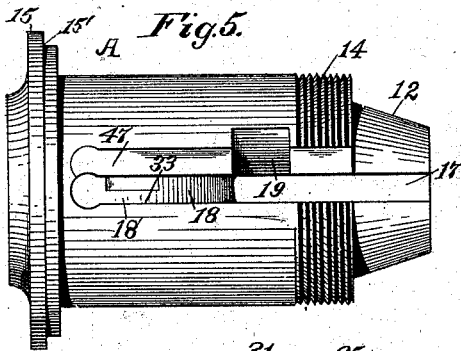
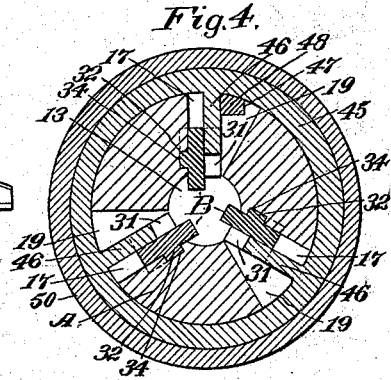
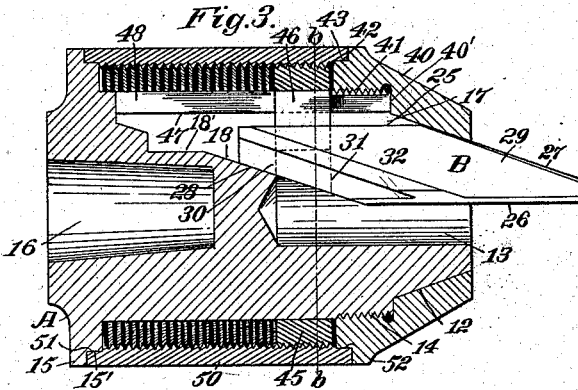
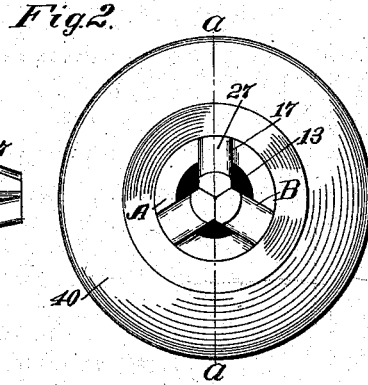
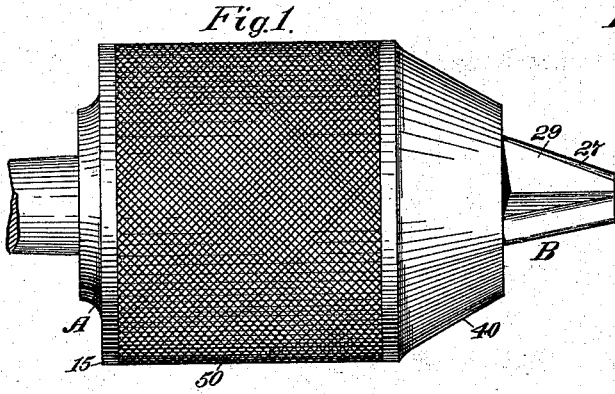

Witnesses:  
R. W. Pittman,  
Fred. J. Dole.

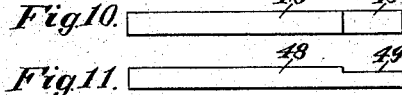

Inventor:  
F. H. Richards.

# UNITED STATES PATENT OFFICE.

FRANCIS H. RICHARDS, OF HARTFORD, CONNECTICUT.

## CHUCK.

SPECIFICATION forming part of Letters Patent No. 562,421, dated June 23, 1896.

Application filed January 24, 1896. Serial No. 576,711. (No model.)

*To all whom it may concern:*

Be it known that I, FRANCIS H. RICHARDS, a citizen of the United States, residing at Hartford, in the county of Hartford and State of Connecticut, have invented certain new and useful Improvements in Chucks, of which the following is a specification.

This invention relates to chucks; and the object of the invention is to provide an improved chuck, such as a drill-chuck, durable in construction and simple in operation, and in which the parts thereof can be quickly and easily assembled, and whereby the cost of construction in devices of this character will be materially lessened.

A further object of this invention is to provide a chuck in which the clamping-jaws thereof can be readily and easily actuated and positively guided in their movements, and by means of which a powerful clamping action can be obtained to thereby firmly and securely hold a tool or other article in position in the chuck.

In the drawings accompanying and forming part of this specification, Figure 1 is a view of this improved chuck complete. Fig. 2 is a right-hand end view thereof. Fig. 3 is a vertical longitudinal sectional view taken in line *a a*, Fig. 2, and having parts thereof in full lines. Fig. 4 is a transverse sectional view of the chuck, taken in a line similar to line *b b*, Fig. 3. Fig. 5 is a view of the body of the chuck, detached. Fig. 6 is a transverse sectional view of the chuck, taken in a line similar to line *b b*, Fig. 3, and showing the operating or actuating member or ring in full lines and moved out of position to permit the insertion of the jaws. Fig. 7 is a transverse sectional view thereof, taken in line *c c* and looking upward, and likewise showing a portion of one of the clamping-jaws in dotted-line position. Fig. 8 is a side view of one of the clamping-jaws. Fig. 9 is a top view thereof. Fig. 10 is a top view of one form of key for use in connection with the actuating member or ring, and Fig. 11 is a side view thereof.

Similar characters of reference designate like parts in all the figures of the drawings.

This improved drill-chuck comprises, in the preferred form thereof herein shown and described, a suitable body (designated in a

general way by A) adapted for attachment to a spindle or mandrel of a lathe or other device, said body having a cone-shaped head 12 and a bore 13 of any desired depth and construction adapted to receive the tool or article to be held by the chuck, and also having, on its circumferential face adjacent to said cone-shaped head 12, suitable screw-threads 14 for the attachment of the conical shell, hereinafter described. The body also has, adjacent to its rear end, a bore 16 of any desired depth, whereby the chuck can be attached to the spindle or mandrel, and an annular flange 15, having, preferably, a right-angled recess 15', for the purpose hereinafter set forth. The chuck-body A also has a series of suitable, longitudinal radial grooves or recesses 17 for the reception of the clamping-jaws, said grooves or recesses extending from the outer peripheral face of said body to and opening into the bore 13, the entire depth of said bore, and also forming inclined seats 18 in the body and preferably in the rear of the bore 13. Any desired number of these longitudinal grooves or recesses 17 may be provided, corresponding, however, with the number of clamping-jaws, and therefore, in the preferred form of chuck herein shown, three recesses or grooves are illustrated to receive the three clamping-jaws herein shown.

Opening into each of the radial longitudinal grooves or recesses 17, and preferably at that portion thereof adjacent to the screw-threads 14, is a transverse recess 19, which extends from the peripheral face of said body, and opens into the bore 13, for the purpose of assembling the parts of the chuck in a manner hereinafter set forth. It will be obvious, however, that said transverse recess 19 may be disposed at any desired place adjacent to the longitudinal recesses or grooves.

The clamping-jaws (designated in a general way by B) may be of any suitable and desired construction adapted for use with this improved chuck; but in the preferred form thereof herein shown and described they comprise a main part 29 and a shank 30, and have horizontal upper and lower faces 25 and 26, united by inclined or beveled faces 27 and 28, whereby the forwardly-inclined faces will be engaged by the interior wall of the conical shell, hereinafter described, and the rear-

wardly-inclined faces 28 will rest and slide on the inclined seats 18 of the body. The shank 30 of each of these jaws B is provided with a perpendicular or transverse recess 31 at one side thereof. This recess may be formed at any suitable place in the jaw; but in the preferred construction of chuck it is preferably formed intermediate of the rear end of said jaw and the juncture of the rearwardly-inclined face 28 with the lower horizontal face 26 thereof, and extends from the upper to the lower edges thereof. The position of this recess will, to a certain extent, regulate the extent of movement of the clamping-jaws, as will be readily understood from this specification. As a means for guiding these jaws on the inclined seats 18 of the body, and also as a means for reinforcing the same, especially at that part thereof where the recesses 31 are formed, each jaw is provided on its side opposite to the recessed side with a relatively long laterally-extending and inclined guiding and reinforcing rib 32, preferably extending from the upper rear corner of the jaw to the lower horizontal edge 26 thereof, whereby the jaw is reinforced at its recessed part or shank, and whereby such recess 31 can be made deeper and the jaws of less thickness, and thus somewhat reduce the size of a chuck for holding a given size of drill or article, and also insuring greater strength and durability of the parts.

As a means for accurately and positively guiding the jaws in their sliding movement and thereby preventing displacement thereof, each radial recess or groove 17 has one of its side walls, as 33, adjacent to its inclined seat 18, provided with a laterally-extending and longitudinally-inclined recess or groove 34 for receiving the laterally-extending and inclined guiding-ribs 32 of the jaws.

In order to clamp the jaws B upon the tool or other article, a conical shell 40, adapted to fit the cone-shaped head 12 of the body A, is provided and has interior screw-threads 41, adjacent to its rear end, for engaging the exterior screw-threads 14 of the body. This conical shell also has an annular flange 42, adjacent to its rear end, forming thereby a right-angled recess 43 in alinement with the right-angled annular recess 15' in the flange 15 of the body A, for the purpose hereinafter set forth. By means of this conical shell, the jaws B, when pressed forward by the actuating means hereinafter described, are forced inwardly toward the axis of the chuck, and the under edges 26 thereof—which are preferably beveled for this purpose—firmly clamp the tool or other article inserted in the bore of the chuck. The preferred actuating means for operating these jaws consists of a non-rotatable exteriorly-threaded member or ring having a series of radial projections or teeth 46, extending inward from said member and toward the center of the chuck, and which projections correspond with the number of jaws, and therefore herein shown as

three in number; and which projections are adapted to engage with the transverse or perpendicular recesses 31 of the jaws, whereby said ring is prevented from rotation, and whereby the jaws are operated on the actuation of said member or ring. By this particular construction of actuating member or ring 45, not only is such member reinforced, to a certain extent, by the inwardly-extending integral projections 46, but the necessity of forming recesses or slots in such member and thereby necessarily weakening the same at such points is obviated, so that the member or ring can be made of less thickness, and thus permit the size of the chuck to be somewhat reduced. Furthermore, by this construction of actuating member or ring, with its projections or teeth 46 entering and closely engaging the walls of the recesses 31 of the jaws, the pressure of the jaws on the member or ring 45 is equalized, so that one part of said member or ring will not be tipped relatively to another part thereof within the rotatable or actuating sleeve, nor otherwise cramped or prevented from having perfect action, whereby the ring will bear normally against the threads of the actuating-sleeve (hereinafter described) and be supported against the pressure of the jaws, so that the wear thereof is evenly and properly distributed over the surface of the screw-threads on the outer face of the ring.

One means for actuating the member or ring 45, and thereby the clamping-jaws B, preferably consists of an actuating or rotatable sleeve 50, having screw-threads on its interior face adapted to engage the screw-threads of the member or ring 45, and also having adjacent to its ends right-angled annular recesses 51 and 52, adapted to engage the annular recesses 15' and 43 of the body and conical shell 40, respectively, whereby the sleeve is guided in its rotation, and whereby on the rotation thereof the actuating member or ring 45 will be moved forward or backward, as required, and the clamping-jaws correspondingly moved to engage or release the tool or article inserted in the bore 13 of the chuck.

In assembling the parts of this improved chuck, the actuating member or ring 45 is placed in position with one of its projections 46 adjacent to each of the longitudinal, radial recesses or grooves 17 of the body, whereby said member can be pushed thereon; and when its projections 46 are in position opposite the transverse recesses 19 said ring is slightly turned to permit said projections 46 to enter such recesses 19, (see Fig. 6,) whereby the radial recesses or grooves 17 are left free from end to end thereof for the reception of the jaws. The jaws B are then inserted into said radial recesses or grooves 17 of the body with their laterally-extending reinforcing and guiding ribs 32 engaging the inclined grooves or guideways 34 of said body and pushed in until their transverse or perpen-

dicular recesses 31 are opposite the transverse recesses 19 of the body. The actuating member or ring 45 is then turned back so that its projections 46 will enter the recesses 31 of the jaws and be free of the transverse recesses 19 of the body, (see Fig. 4,) whereby both the jaws B and the actuating member or ring 45 can be moved in either direction in the longitudinal radial recesses 17 of the chuck.

Any suitable means may be used for preventing the projections 46 of the actuating member 45 from reëntering the transverse recesses 19 when moved opposite to such recesses. For instance, the transverse recesses 19 might be made with a part thereof extending into the threaded portion 14 of the body A, whereby the inner end of the conical shell 40, when in position, will extend over a portion of said recess, and thus prevent the re-entrance of said projections therein; or the transverse recesses 19 may be entirely dispensed with, and the projections 46 inserted through the rim of the member 45 and held therein in any suitable way, so that said projections can engage the jaws after said jaws are in position. This construction, however, is not a preferable one, owing to the necessity of forming apertures through the ring for the reception of the projections, and thus weakening such ring; but in the preferred form of means best adapted with this construction the body has a keyway 47 extending in parallelism with one of the longitudinal recesses or grooves 17 from the rear end thereof to the inner portion of the cone-shaped head 12 for the reception of a suitable key 48. This key in the form shown is cut away, as at 49, adjacent to one of its ends, to permit the conical shell to engage the threads 14 of the body. When the key is inserted in position in the keyway, the projections 46 will be prevented from entering said transverse recesses 19, in a manner which will be clearly understood without further description. The actuating or rotatable sleeve 50 is then placed in position with its screw-threads engaging the threads of the actuating member or ring 45, and the conical shell 40 then screwed onto the cone-shaped head 12, and the chuck is then ready for use in the preferred construction shown in Fig. 1.

As one means for preventing the key 48 from working longitudinally out of its way 47—although any other suitable means may be used for this purpose—the conical shell is shown of less interior diameter at that part thereof fitting on the cone-shaped head 12 of the body than at its screw-threaded part 41, whereby it will form a wall 40', which will engage the end of the key. In this construction of shell 40, the cone-shaped head 12 of the body A will be made, in practice, somewhat smaller than the main part of said body A, whereby the shell will also be prevented from moving too far on the body.

Adjacent to the rear end of each inclined

seat 18 a suitable recess 18' is formed, to permit the ends of the projections 46 to be moved as far toward the rear of the chuck as may be desired with relation to the position of the transverse recesses 31 of the jaws.

In this improved construction of chuck, not only is the same simple in construction and operation, but the clamping-jaws can be moved simultaneously and uniformly on the operation of the actuating member or ring, and guided positively against displacement or wobbling, and can be made somewhat smaller than is now ordinarily the case, and at the same time much stronger. The actuating member or ring will also have the pressure of the jaws thereon always equalized, so that said ring will bear normally against the threads within the actuating-sleeve, and thus the wear be evenly and properly distributed over the entire surface of the screw-threads on the outer face of said member or ring, while said ring will not be weakened by means of recesses or slots therein.

Having thus described my invention, I claim—

1. The combination of a chuck having a clamping-jaw movable therein, and an actuating member having a radial projection extending inward from said member and toward the center of said chuck, and adapted to engage said jaw to actuate the same.

2. The combination of a chuck having a clamping-jaw movable therein, said jaw having a recess, and an actuating member having a radial projection extending inward from said member and toward the center of said chuck, and adapted to enter the recess of said jaw to actuate said clamping-jaw.

3. In a device of the class specified, the combination of a body having a bore for the reception of a tool or article, and also having a radial recess opening into said bore; a clamping-jaw movable in said radial recess and having a recess; and a non-rotatable actuating member having a radial projection extending inward from said member and toward the center of the body, and adapted to engage the recess of the jaw whereby said jaw can be actuated.

4. In a device of the class specified, the combination of a body having a bore for the reception of a tool or article, and also having radial recesses opening into said bore; clamping-jaws movable in said radial recesses, and each of said jaws having a recess; an actuating member having a series of radial projections extending inward from said member and toward the center of the body, and adapted to engage the recesses of the jaws whereby said jaws can be actuated; and means for operating said actuating member and thereby the jaws.

5. In a chuck, the combination of a body having a bore for the reception of a tool or article, and having radial recesses opening into said bore and forming inclined seats, and also having laterally-extending and inclined

grooves in the sides of said recesses; clamping-jaws movable in said radial recesses, each of said jaws having an inclined guide-rib extending from the upper rear end of said jaw  
 5 to the lower horizontal edge thereof, and adapted to move in said laterally-extending grooves; and an actuating member for said jaws.

6. In a chuck, the combination of a body  
 10 having a bore for the reception of a tool or article, and having radial recesses opening into said bore and forming inclined seats, and also having laterally-extending and inclined  
 15 grooves in the sides of said recesses; clamping-jaws movable in said radial recesses, each of said jaws having a recess at one side thereof and an inclined guide and reinforcing rib at the opposite side thereof, and extending from  
 20 the upper rear end of said jaw to the lower horizontal edge thereof; and a non-rotatable actuating member having inwardly-extending projections adapted to engage the recesses of the jaws for actuating the same.

7. In a chuck, the combination of a body  
 25 having a bore for the reception of a tool or article, and having radial recesses opening into said bore and forming inclined seats, and also having laterally-extending and inclined grooves in the sides of said recesses; clamping-jaws movable in said radial recesses, and each of said jaws having a recess at one side thereof and an inclined reinforcing and guide  
 30 rib at the opposite side thereof and extending from the upper rear end of said jaw to the lower horizontal edge thereof; a non-rotatable actuating member having inwardly-extending  
 35 projections adapted to engage the recesses of the jaws for actuating the same; and a rotatable sleeve for actuating said non-rotatable  
 40 member, and thereby the jaws.

8. In a chuck, the combination of a body having a bore for the reception of a tool or article, and having radial recesses opening  
 45 into said bore; and also having transverse recesses opening into said radial recesses, whereby the parts of the chuck can be assembled; clamping-jaws movable in said radial recesses, and each of said jaws having a recess; and an actuating member having inwardly-extending projections adapted to engage the recesses of the jaws, whereby said  
 50 jaws can be actuated.

9. In a chuck, the combination of a body  
 55 having a bore for the reception of a tool or article, and having radial recesses opening into said bore, and also having transverse recesses opening into said radial recesses, whereby the parts of the chuck can be assembled; clamping-jaws movable in said radial  
 60 recesses, and each of said jaws having a recess; an actuating member having inwardly-extending projections adapted to engage the recesses of the jaws, whereby said jaws can be actuated; and means for preventing the  
 65 projections of said actuating member from entering the transverse recesses of the body during the ordinary operations of the jaws

10. In a chuck, the combination of a body having a bore for the reception of a tool or article, and having radial recesses opening  
 70 into said bore, and also having transverse recesses opening in said radial recesses, whereby the parts of the chuck can be assembled; clamping-jaws movable in said radial recesses, and each of said jaws having a recess; and  
 75 an actuating member having inwardly-extending projections adapted to engage the recesses of the jaws, whereby said jaws can be actuated; means for preventing the projections of said actuating member from entering the transverse recesses of the body during the ordinary operation of the jaws; and  
 80 a rotatable sleeve for engaging said actuating member, and thereby operating the same to actuate the jaws.

11. In a chuck, the combination of a body having a bore for the reception of a tool or article, and having radial recesses opening  
 90 into said bore, and also having transverse recesses opening into said radial recesses, whereby the parts of the chuck can be assembled; clamping-jaws movable in said radial recesses, and each of said jaws having a recess; an actuating member having inwardly-extending projections adapted to engage the recesses of the jaws, whereby said jaws can be  
 95 actuated; and means for preventing the projections of said actuating member from entering the transverse recesses of the body during the ordinary operation of the jaws, and comprising a keyway extending in parallelism  
 100 with a portion of one of said radial recesses, and into which one of said transverse recesses opens; and a key disposed in said way.

12. In a chuck, the combination of a body  
 105 having a bore for the reception of a tool or article, and having radial recesses opening into said bore and forming inclined seats in the rear thereof, and also having transverse recesses opening into said radial recesses, and  
 110 laterally-extending and inclined grooves at the sides of said recesses; clamping-jaws movable in said radial recesses, and each of said jaws having a recess at one side thereof and an inclined reinforcing and guide rib at  
 115 the opposite side thereof and adapted to engage an inclined groove of the body; an actuating member having inwardly-extending projections adapted to engage the recesses of the jaws, whereby said jaws can be actuated; means for preventing the projections of said actuating member from entering the transverse recesses of the body during the ordinary operation of the jaws, and comprising a keyway extending in parallelism with one of said radial recesses, and into which one of said transverse recesses opens; and a key disposed in said way; and a rotatable sleeve for engaging said actuating member, to thereby actuate the jaws.

13. In a chuck, the combination of a body  
 130 having a bore for the reception of a tool or article, and having radial recesses opening into said bore and forming inclined seats in

the rear thereof, and also having laterally-extending and inclined grooves in the sides of said recesses; clamping-jaws movable in said radial recesses, and each of said jaws having an inclined lower edge adapted to engage an inclined seat, and a laterally-extending and inclined reinforcing and guide rib at one side, and extending from the upper rear end of said jaw to the lower horizontal edge thereof and guided in said laterally-extending groove, and also having a transverse recess at the opposite side and extending from the upper to the lower edges thereof; and a non-rotatable member having inwardly-extending projections for engaging the recesses of the clamping-jaws, to thereby actuate the same.

14. In a chuck, the combination of a body having a bore for the reception of a tool or article, and also having radial recesses opening into said bore; clamping-jaws movable in said radial recesses, and each of said jaws having a transverse recess at one side thereof and extending from the upper to the lower edges thereof; and a non-rotatable actuating member or ring having inwardly-extending projections adapted to engage the recesses of the jaws, whereby said jaws can be actuated.

15. In a device of the class specified, the combination of a body having a bore for the reception of a tool or article, and also having a series of radial recesses opening into said bore; a series of clamping-jaws movable in said radial recesses and each of said jaws having a recess; an actuating member having a series of inwardly-extending radial projections adapted to engage the recesses of the

jaws and slide therein on the movement of said jaws.

16. In a device of the class specified, the combination of a body having a bore for the reception of a tool or article, and also having a series of radial recesses opening into said bore; a series of clamping-jaws movable in said radial recesses, and each of said jaws having a recess; an actuating member or ring having screw-threads on its periphery, and also having a series of inwardly-extending projections adapted to engage the recesses of the jaws and slide therein on the movement of said jaws; and an interiorly-threaded rotatable sleeve for operating the actuating member.

17. In a device of the class specified, the combination of a body having a cone-shaped head having a bore for the reception of a tool or article, and also having a series of radial recesses opening into said bore; a series of clamping-jaws movable in said radial recesses, and each of said jaws having a recess; an actuating member having a series of inwardly-extending projections adapted to engage the recesses of the jaws and slide therein on the movement of said jaws; a conical shell disposed on said body and adapted to move said jaws inwardly on the movement thereof by the actuating member; and a rotatable sleeve engaging said actuating member for operating the same, and thereby the jaws.

FRANCIS H. RICHARDS.

Witnesses:

R. W. PITTMAN,  
FRED. J. DOLE.